

Terrible Presentations

(...and how to not give one)

Sakis Mantalaris

W.H. Coulter Department of Biomedical Engineering
Georgia Tech & Emory

Why A Good Presentation?

- You want people to:
 - Understand your work
 - Be **INTERESTED** in your work
 - Think you're great!

- What happens if you give a bad one?
 - Few pay attention
 - They may fall asleep
 - Might think your work is not important



What You Want Them to Know!

1. Tell them what you are going to tell them
2. Tell them (mean what you say and say what you mean!!!)
3. Tell them what you told them

*think about how much you can legitimately take away from a talk, even when you are really, really interested.

*you may think you are repeating yourself too much, but probably not!

Tips For Presenting

- How to give GOOD presentations:
 - Part I: Presence
 - Attitude
 - Voice
 - Mannerisms
 - Part II: Slide style
 - Understandable
 - Interesting
- Will show examples of what NOT to do

Part I

- Keep audience interested
- Keep them with you

- Things that can affect this
 - Topic, topic depth
 - Attitude/Presence
 - Mannerisms

Know Your Topic

- Be prepared to get questions!
- “What if I don’t know the answer?”
 - Know WHEN to say “I don’t know”
 - Know HOW to say “I don’t know”
 - Don’t just stand there uncomfortably!
- Be able to recover from interruptions
- Know what to skip if you’re running late
 - Don’t just talk faster!

Know Your Audience

- Do they have a background like yours?
- How much hand-holding?
- Can you jump right in to specifics?
- How much motivation for your work?
- How detailed should you get?

Know Your Location

- Need to bring a laptop?
- Need to bring a CD, or email a PPT in advance?
- Need to print transparencies?
How far is audience from screen?
- Can you point with your hand, or do you need a laser pointer?

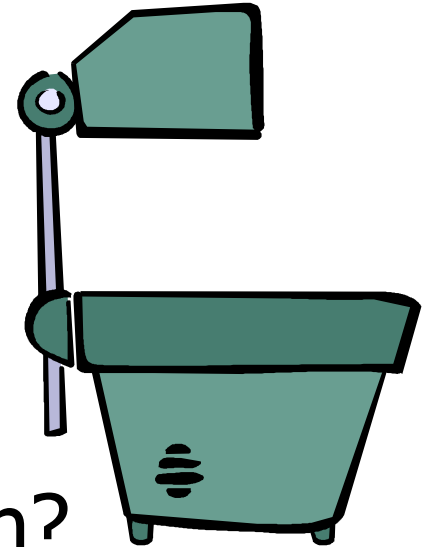

Attitude. (Yours)

- Are you INTERESTED in your topic?
 - If no, get a different one!
 - If yes, ACT LIKE IT
- If *YOU* aren't excited...
 - Can't expect *OTHER* people to be!
- Don't talk down to audience
 - You know more than them about THIS...
 - They know more than you about other stuff

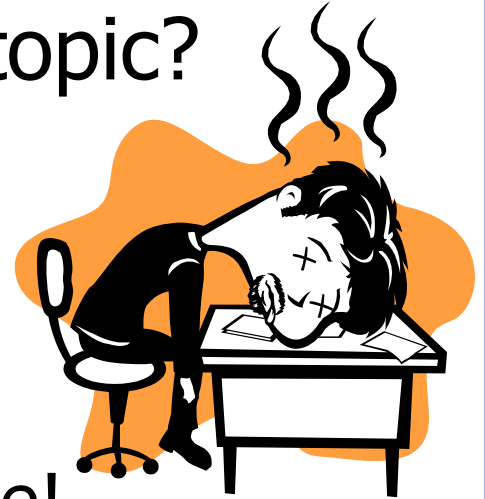

Know Your Audience!

1. Super Nerds
2. The Lost
3. Temporary Slackers*

*Temporary slackers are super nerds who weren't paying attention to your last slide, but feel a strong need to understand and reorient quickly.

Dead Man Talking

- Are you hiding behind the podium?
- Are your hands/face motionless?
- Are you staring...
 - at your advisor/boss?
 - at your laptop?
 - at the screen?
 - at the ceiling?
- Is your back to the audience?
- IF SO... you're probably BORING!

I Drank A Case Of Mountain Dew!

- Sometimes nerves make for fast talking
- Calm down. E-nun-see-ate.
- It's not a race
 - People need time to absorb information
- Take a bottle of water if necessary
 - Bottles if you can work a cap (spillage)
 - Glass if you're using a laser pointer

Is This Thing On <tap tap>?

- Feedback kills people!
- Most PA systems are tuned so that the microphone can be middle of your chest
 - Not 2mm from your mouth
- Modulate your voice evenly
- Careful – turning head affects volume!
- If not using a mic – project your voice!

Where are your hands?

- You have a set of “moves” that repeat during your talk
- Make sure they aren’t silly looking
 - Don’t point with your middle finger
- Can videotape yourself speaking
- Do a practice for friends
 - Make sure they’re not too nice
 - You want real feedback!



Look Ma, I have a L-A-S-E-R!

- If necessary, get a laser pointer
 - Will depend on your talk
- Get it a few weeks before your talk
 - Play with it. Circle things. Make shapes.
 - Be comfortable
 - Get Borg impersonations out of the way
- Get a second one for backup, or make sure session chair/host has one

Common Laser Pointer Moves

- The circle
- The underline
- The back-handed flick
- The epileptic-seizure inducer

- **DO NOT POINT AT EVERYTHING**
 - Not everything is equally important
 - Your voice can provide emphasis too

Right Here. See?

- Don't point at your laptop screen
 - They can't see it



Ummmm... The... Uh... Yeah.

- Practice makes perfect
 - Caveat: OVER practicing can be bad...
- Do not read your slides like a script
- Most people lose 20 IQ points in front of an audience



Part II: Slide Design

- Goals:
 - Convey the necessary information
 - Be readable/understandable
 - Be interesting (enough)

- Avoid:
 - Over stimulation
 - Booooring

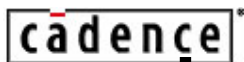

Logos



- We know you had support
- Don't need to list all of them every slide
- If on first slide, don't obscure title/authors
- Maybe save it for last slide



MARATHA STEWART



Outline

- Title Slide
- Introduction
- Outline
- My Work
- Results
- Conclusions

Part II: Slide Design

- Keywords:
 - 5 keywords per slide
 - Talk about and around keywords
- Links:
 - Previous slide links to the next
 - All slides link to the title
 - All slides link to the conclusions

Outline Slides

- Previous slide didn't "help" audience
- If use outline slide, make it USEFUL
 - Everyone (hopefully) introduces their topic
 - Everyone explains their work, gives results
 - What is specific to YOUR talk?
- Talk length correlates to outline need
 - Talk is 45 minutes, maybe!
 - Talk is 5 minutes... probably not.

README.TXT

- Do not attempt to put all the text, code, or explanation of what you are talking about directly onto the slide, especially if it consists of full, long sentences. Or paragraphs. There's no place for paragraphs on slides. If you have complete sentences, you can probably take something out.
- If you do that, you will have too much stuff to read on the slide, which isn't always a good thing.
- Like the previous slide, people do not really read all the stuff on the slides.
 - That's why it's called a "presentation" and not "a reading" of your work
- Practice makes perfect, which is what gets you away from having to have all of you "notes" in textual form on the screen in front of you.
- Utilize the Notes function of PowerPoint, have them printed out for your reference.
 - The audience doesn't need to hear the exact same thing that you are reading to them.
 - The bullet points are simply talking points and should attempt to summarize the big ideas that you are trying to convey
- If you've reached anything less than 18 point font, for God's sake, please:
 - Remove some of the text
 - Split up the text and put it on separate slides
 - Perhaps you are trying to do much in this one slide?
- Reading a slide is annoying.
- You should not simply be a text-to-speech converter.

Font Size

- You are close to your monitor
- Your audience is far from the screen

Tahoma	TNR	Courier	Comic	Lucida Sans
32 pt	32 pt	32 pt	32 pt	32 pt
28 pt	28 pt	28 pt	28 pt	28 pt
24 pt	24 pt	24 pt	24 pt	24 pt
20 pt	20 pt	20 pt	20 pt	20 pt
18 pt	18 pt	18 pt	18 pt	18 pt
16 pt	16 pt	16 pt	16 pt	16 pt
14 pt	14 pt	14 pt	14 pt	14 pt
12 pt	12 pt	12 pt	12 pt	12 pt
10 pt	10 pt	10 pt	10 pt	10 pt

Squint City

- If you find yourself saying “you probably can’t read/see this, but...”
 - Then you probably have a BAD SLIDE!
 - There are exceptions, but very few
- Test on real screen in conference room
 - Not just your computer screen 15” away.

This is a really long title for
this single slide, I should have

just summarized

- Hard to read
- Many people don't read the title anyway
- Should have been "Long Slide Titles"

Know Slide Boundaries

- People can't read text that runs off the side of

Bullets Aren't Everything

- How many
 - Levels of
 - Hierarchy do
 - You think
 - » You need
 - * To express
 - Your point?

Speelchick

- How samrt will poeple thikn yuo are?
- Watch for:
 - there/their/they're
 - too/to/two
 - its/it's

Picture This

- There are exceptions, but in general
 - Don't have only text on most of your slides
 - Try to draw diagrams wherever applicable
- (Well-drawn) pictures easier to understand

System Architecture

- There's a CPU, a RAM and an FPGA and they're all connected
 - The FPGA connects to the CPU's data cache
 - The bus is 32 bits wide
 - Blah blah blah blah
- You have to visualize it yourself

System Architecture

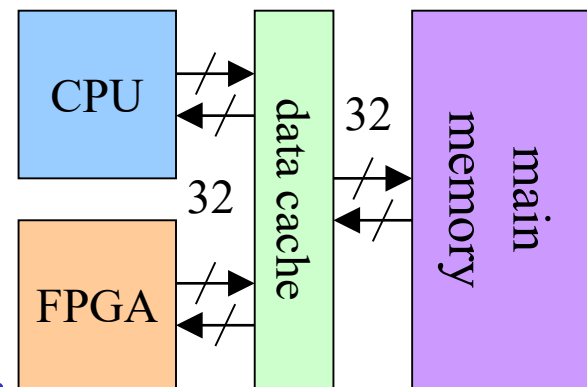

Example Diagrams

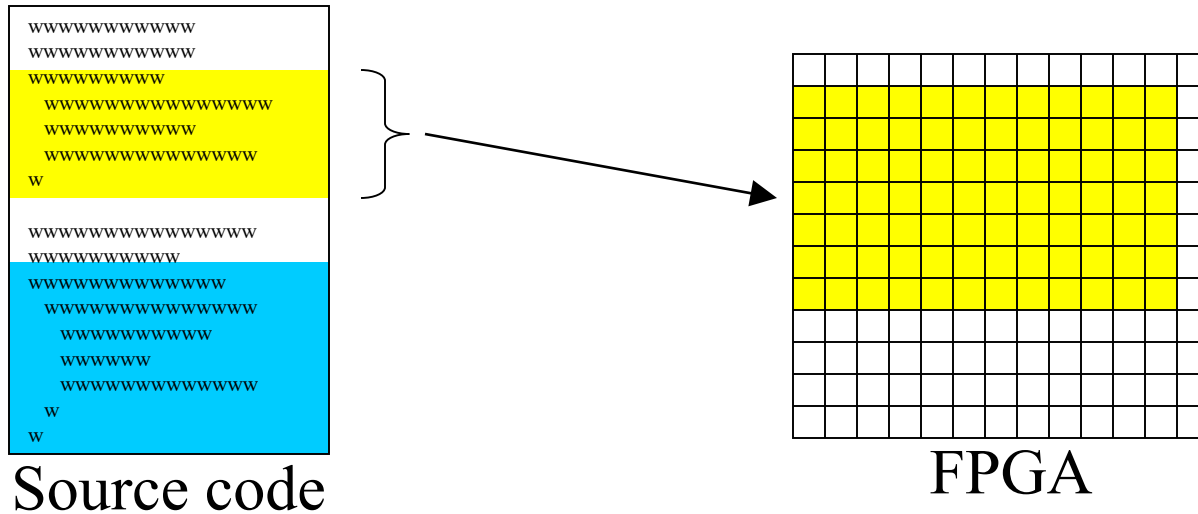

- Compute-intensive sections on hardware
- Hardware reconfigured for each

Example Diagrams

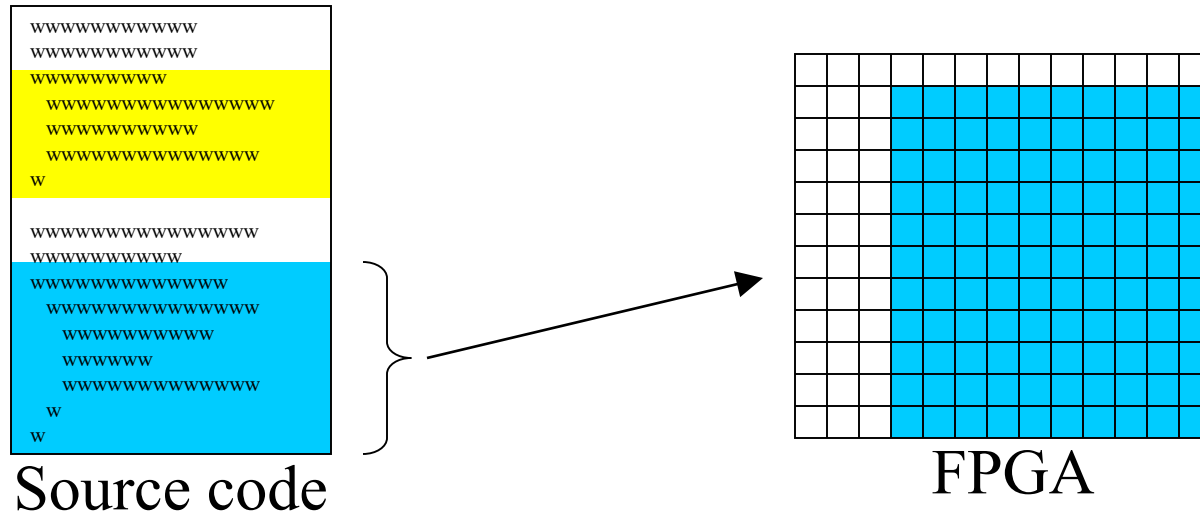

- Compute-intensive sections on hardware
- Hardware reconfigured for each

You are not Pixar Studios

- Previous slide(s) used “animation” ...

Animation

Use it sparingly

Can

(it can be annoying)

Be Very

Distracting

- Use only where it is USEFUL
- Know if presentation system will handle
 - Different versions of PowerPoint, Macs, etc.
- Or use multiple slides to safely animate
 - Flip-book style

Line 'Em Up

- This is a bad drawing
- Put in some effort

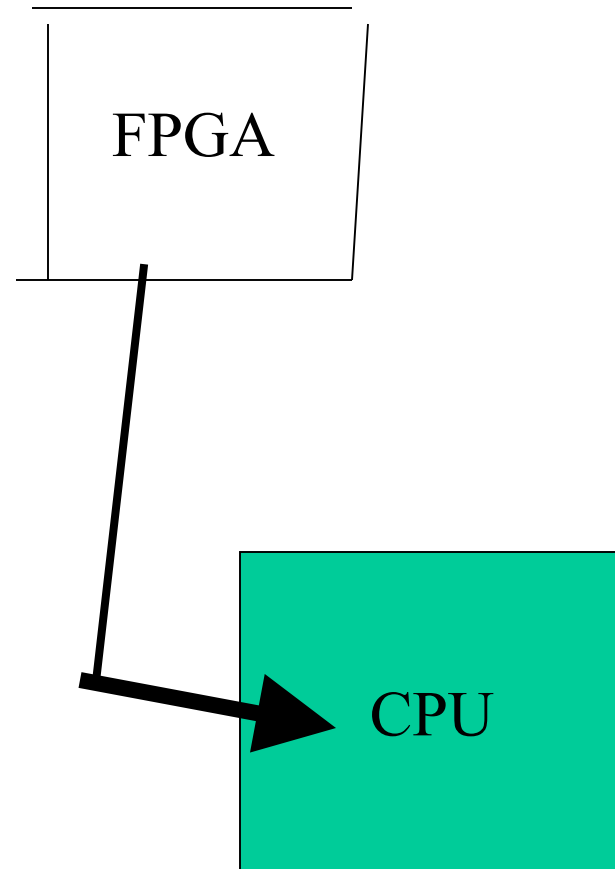

The Art of Suspense

The Art of Suspense

- Don't

The Art of Suspense

- Don't
- Be

The Art of Suspense

- Don't
- Be
- A

The Art of Suspense

- Don't
- Be
- A
- Tease

Anticipatory Lecturing

- Don't Be A Tease
- Let the audience think at their own pace
- It only provides benefit if there's a "surprise" result

Mommy, my eyes are burning!

- Can you look at this for 45 minutes?
- Colors look different on every LCD projector
- Colors look different between transparencies and projector
- Side note: if printing slides, may want to choose white background to save ink!

I See A Ghost

- More contrast on monitor than projector
- Different projectors == different results
- Colors to avoid with white are:

- Light Green

- Light Blue

- Pale Yellow



Usually can't read this...

- Your slides should have good contrast

Contrast Guidelines

- White background, black text is clearest
 - Can use other (dark) text colors...
 - But be careful -- don't be distracting!
- Make sure to not use light-on-white or white-on-light
- Don't using glaring colors
 - If not an art major, don't have to get fancy

Equations

$$X' = A * B$$

$$= (A - (2^p - 1)) * (B - (2^q - 1))$$

$$= AB - B(2^p - 1) - A(2^q - 1) + (2^p - 1)(2^q - 1)$$

$$X'' = (A - E_p)(B + E_q)$$

$$= AB + AE_q - BE_p - E_p E_q$$

$$= AB + AE_q - (BE_p + E_p E_q)$$

$$= AB + AE_q - \frac{E_p E_q}{2} - \left(BE_p + \frac{E_p E_q}{2} \right)$$

$$f(X', X'') = \frac{\Gamma}{2} \sum \frac{\frac{X' \delta \alpha \max(\phi^2)}{X'' \Gamma^{3/2}} \sum \epsilon \sqrt{AB + AE_q - \frac{E_p E_q}{2} - \left(BE_p + \frac{E_p E_q}{2} \right)}}{\int_R \phi \rho f(\vec{X} | S_k) \frac{1}{(2\pi)^{d/2} \sigma^d} * \frac{1}{P_k} \sum_{i=1}^{P_k} \exp \left[-\frac{(\vec{X} - \vec{W}_{ki})^T (\vec{X} - \vec{W}_{ki})}{2\sigma^2} \right]}$$

- Ummm... okay...

Keep It Simple

- Do you really need all those equations?
 - This is very instance-dependent!
 - Depends on what you're discussing
 - Depends on your audience
- Sometimes you may need them
 - Explain the variables and what they mean
 - Give a "plain-text" description of it
- If you don't need them, don't use them!

Use Simple Examples

- This isn't one. It doesn't help.

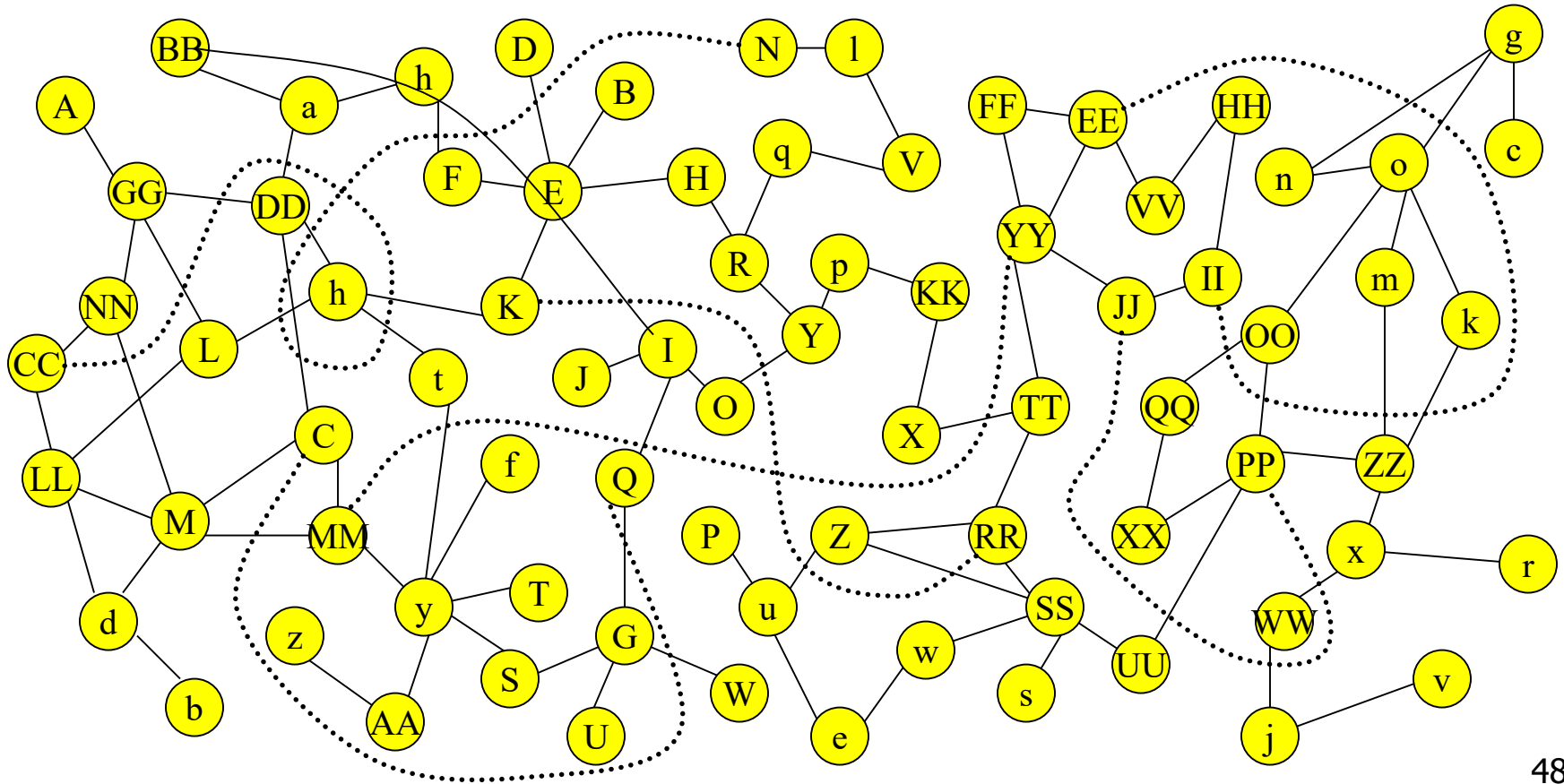

Results

A B C D E

- You have lots of cool results
 - No one can read this
 - No one can understand this

0.78799174	0.87677244	0.99348605	0.23781547	0.24437526
0.24910355	0.79708654	0.39825661	0.4894876	0.22079456
0.65729261	0.46901063	0.36471191	0.04697233	0.63468059
0.48205396	0.52657506	0.70503426	0.35280176	0.40935313
0.46328137	0.0774365	0.71517444	0.9394662	0.46843638
0.09762717	0.70884867	0.81407539	0.24571711	0.72497819
0.00773315	0.39906447	0.42344939	0.90776976	0.22209006
0.15857663	0.4181197	0.56488165	0.91405841	0.3578349
0.59242455	0.17894389	0.61926672	0.02978346	0.50789172
0.41285757	0.71470398	0.31906988	0.79658426	0.21587647
0.8855586	0.46534556	0.3701164	0.12452538	0.33415497
0.28231467	0.17509894	0.85801024	0.72984635	0.94731238
0.82370951	0.03235362	0.95622299	0.27726297	0.76619879
0.86245578	0.21094811	0.93272287	0.48265505	0.04960646
0.38953201	0.3665743	0.33754918	0.28178635	0.39637009
0.80522838	0.63509032	0.43333321	0.97677807	0.96198172
0.35928212	0.14878634	0.44201417	0.23251612	0.83375154
0.72099806	0.75212293	0.81061259	0.23756284	0.48518996
0.13329065	0.31602317	0.87489249	0.5304632	0.26191565
0.2588109	0.89039838	0.81380512	0.59139955	0.48488759
0.99314419	0.34635186	0.73292414	0.25933239	0.29230491
0.88041055	0.11473455	0.01934078	0.15717245	0.93780676
0.72332226	0.80195173	0.1792961	0.07832254	0.41154579
0.95925002	0.41696749	0.24905812	0.2111233	0.00256536
0.00580885	0.65322119	0.49666074	0.91641276	0.40573275
0.26004883	0.3010126	0.45604195	0.99935168	0.91271048
0.1508427	0.84418604	0.96241158	0.05548096	0.94093154
0.63750743	0.08979734	0.11100042	0.34646613	0.09994533
0.17176871	0.85518113	0.94522781	0.29368901	0.77444161
0.15186964	0.53105474	0.69991523	0.07876247	0.0023978
0.72306385	0.73755246	0.71402806	0.68090612	0.76015636
0.42140074	0.39036871	0.02247591	0.94725973	0.70692042

- Graphs are your friend...

Graphs Can Also Be The Enemy

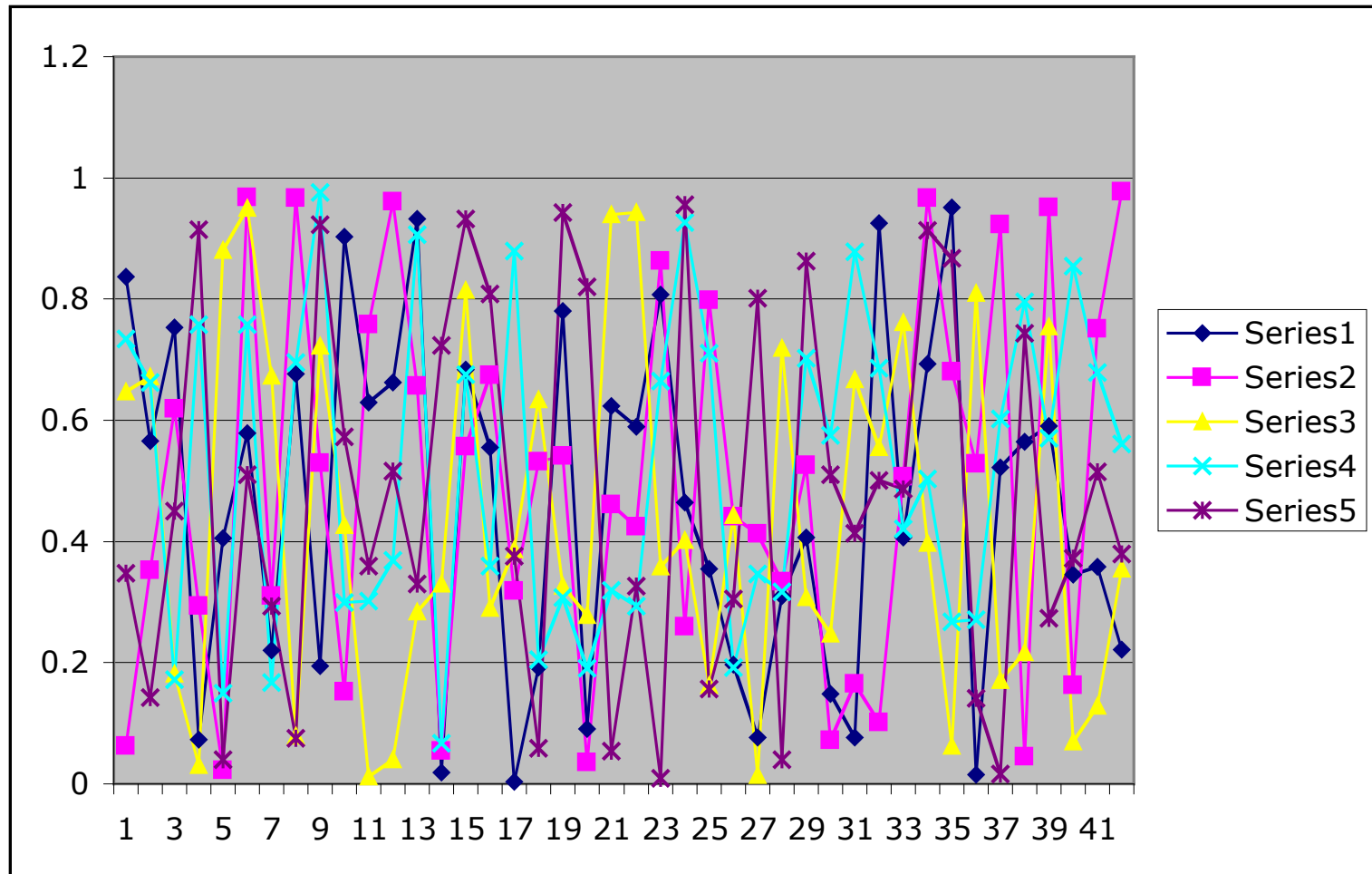

Pick A Line, Any Line

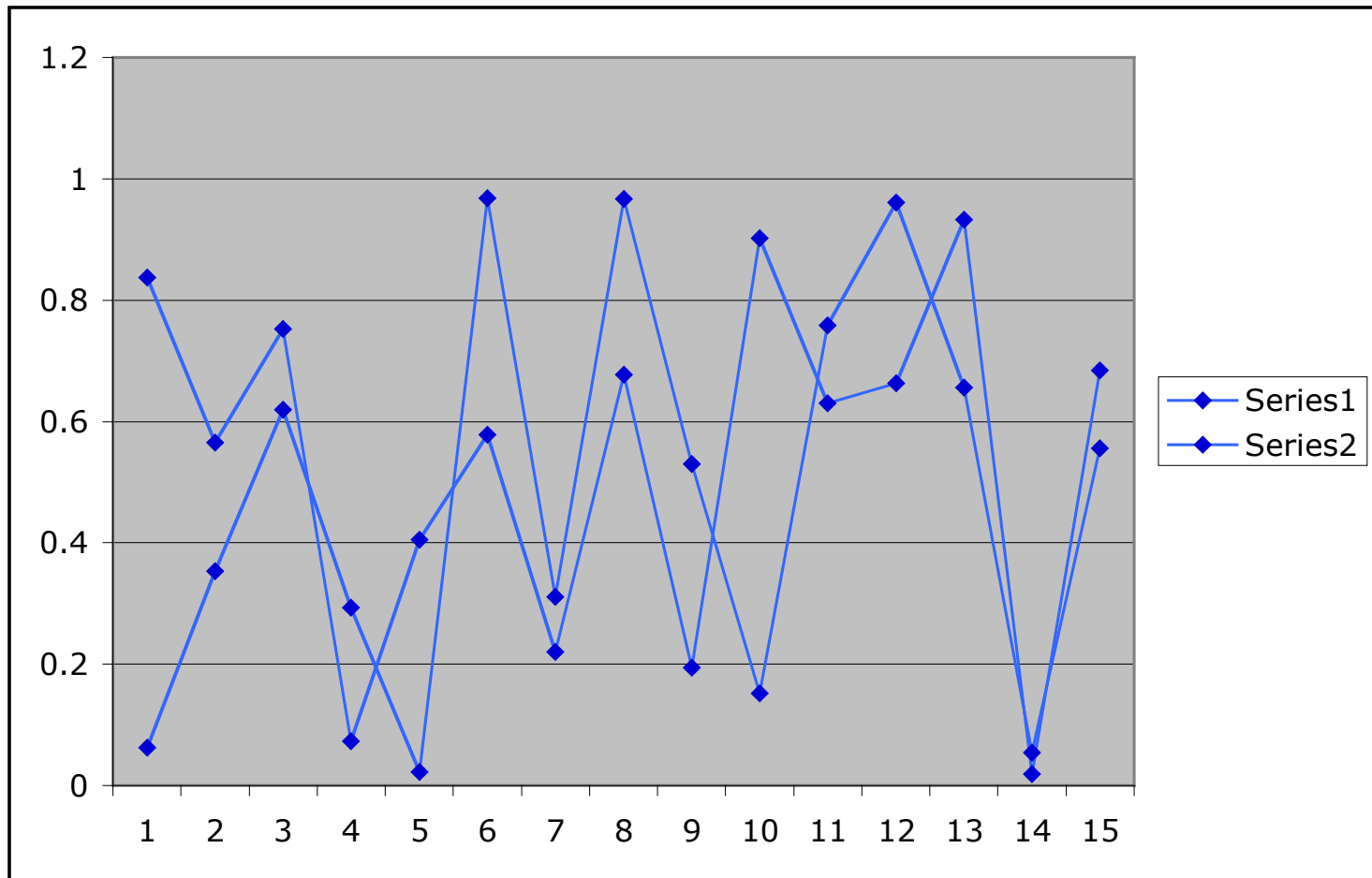

Summary/Conclusion

- If your talk is more than 5 minutes, nice to summarize work & results
 - Bring people back if they zoned out
 - Remind them why you're great
- Give "selling" points here
 - 30x performance increase with only 10% area penalty
 - Described novel method to create clean fuel from used cat litter

Bad Presentations

- Audience won't see your work is great
- But will make fun of you from back row

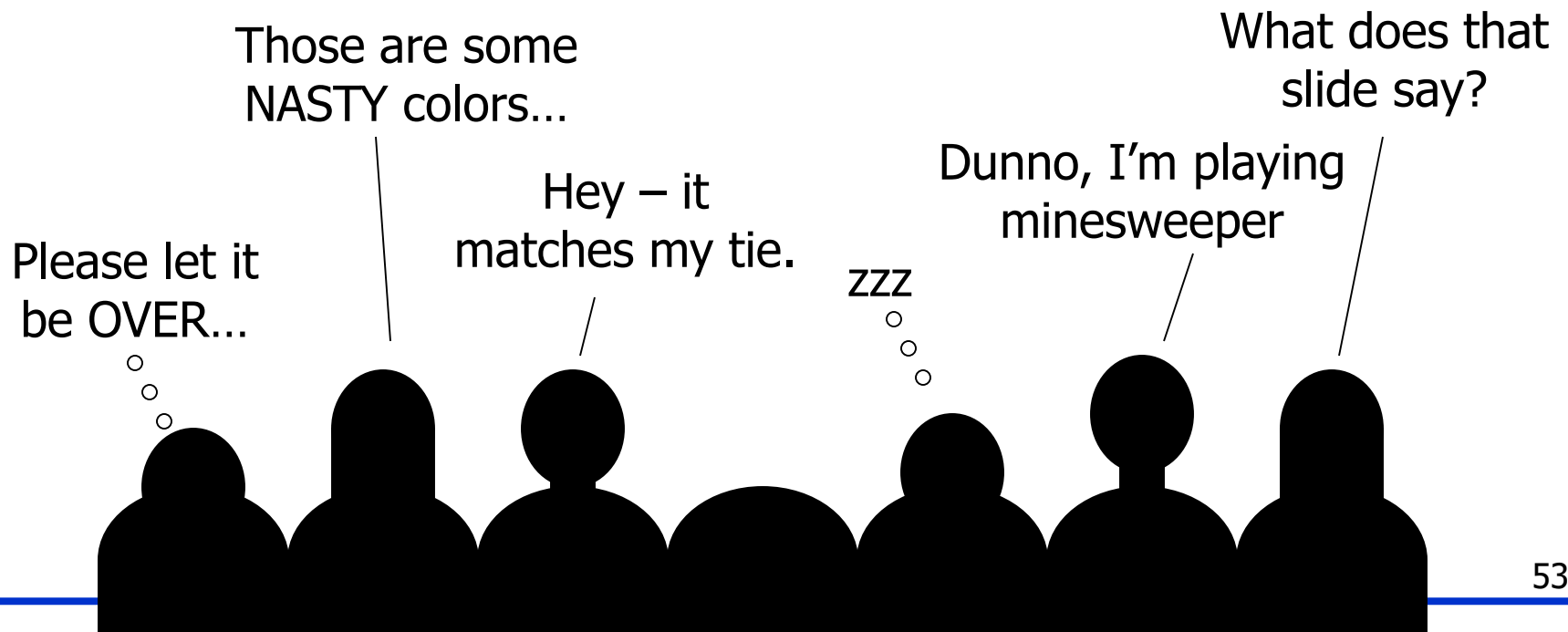

Good Presentations

- Interesting topic, explained at audience's level
- Slides are understandable and easy to see
- Good presentations reflect well on speaker!

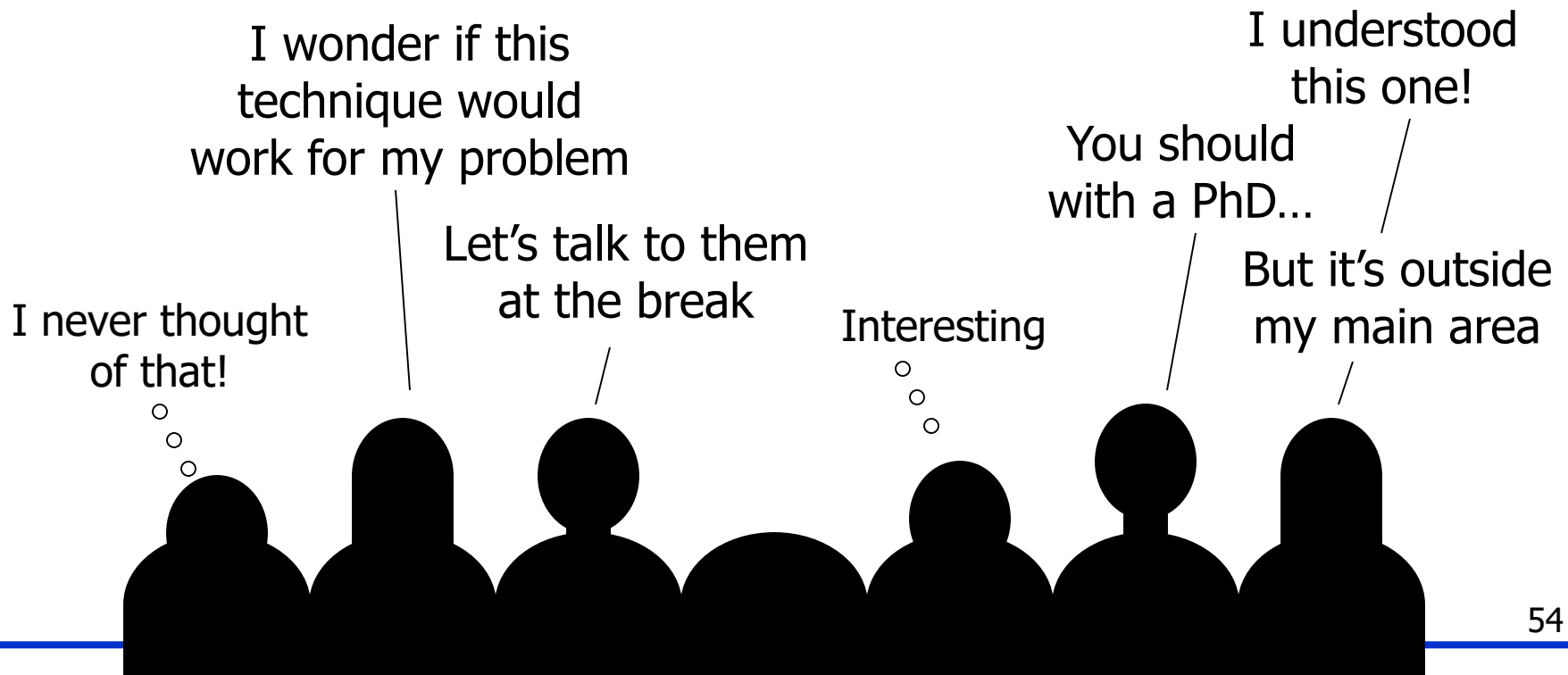

Summary

- YOU ARE IN CONTROL!!!
- Have ONE message you want to deliver
- Know your audience!
 Know your audience, know your audience, know your audience
- Prepare!
- Practice!
- Thank the people who helped you!
 Nicki Panoskaltsis, (not your mum, dad, siblings)